

1

2

3

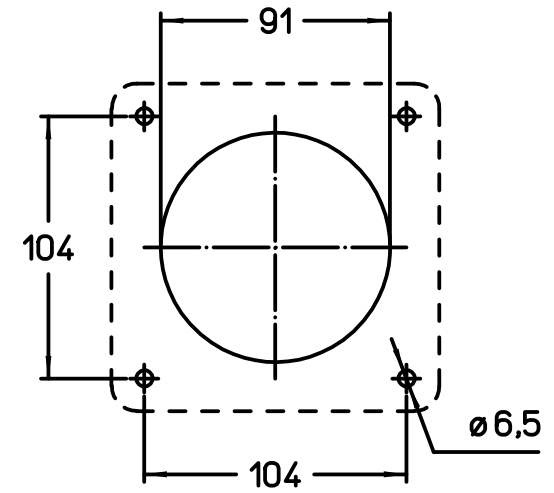
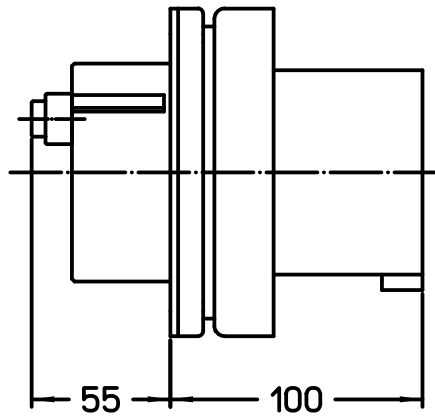
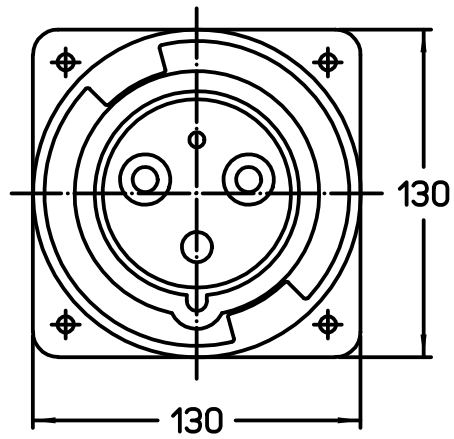

REV.	DATE	SIGNATURE		
Dimensions in mm		Simplified representation with dimensions without tolerance		
Original Size A4		PEW 12563 SI		Scale 1:3
Date 09/02/21		125A 2P+⊖ APPLIANCE INLET, IP66/IP67		
Sign. S. Diasparra				

1

2

3